

### Description

DLLC03I a 3.3V uni-directional TVS diode, utilizing leading monolithic silicon technology to provide fast response time and low ESD clamping voltage, making this device an ideal solution for protecting voltage sensitive high-speed data lines. The DLLC03I has a low capacitance with a typical value at 1.0pF, and complies with the IEC 61000-4-2 (ESD) standard with ±30kV air and ±30kV contact discharge. It is assembled into a lead-free SOD-323 package. The small size, low capacitance and high ESD surge protection make DLLC03I an ideal choice to protect cellphone, wireless systems, and communication equipment.

### Features

- ◆ Ultra low capacitance : 1.0pF typical
- ◆ Ultra low leakage: nA level
- ◆ Low Operating: 3.3V
- ◆ Low clamping voltage
- ◆ Protects one power line or data line
- ◆ Complies with following standards:
  - IEC 61000-4-2 (ESD) immunity test  
Air discharge: ±30kV  
Contact discharge: ±30kV
  - IEC61000-4-4 (EFT) 40A (5/50ns)
- ◆ RoHS Compliant

### Mechanical Characteristics

- ◆ Package: SOD-323
- ◆ Lead Finish: Matte Tin
- ◆ Case Material: “Green” Molding Compound.
- ◆ UL Flammability Classification Rating 94V-0
- ◆ Moisture Sensitivity: Level 3 per J-STD-020
- ◆ Terminal Connections: See Diagram Below
- ◆ Marking Information: See Below

### Applications

- ◆ USB Ports
- ◆ Smart Phones
- ◆ Wireless Systems
- ◆ Ethernet 10/100/1000 Base T

### Dimensions and Pin Configuration

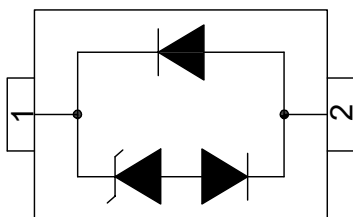

Circuit and Pin Schematic

### Marking Information

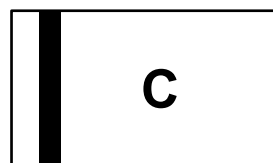

C= Device Marking Code

### Ordering Information

Part Number	Marking	Packaging	Reel Size
DLLC03I	C	3000/Tape & Reel	7 inch

### **Absolute Maximum Ratings ( $T_A=25^{\circ}\text{C}$ unless otherwise specified)**

Parameter	Symbol	Value	Unit
Peak Pulse Power (8/20 $\mu\text{s}$ )	Ppk	340	W
Peak Pulse Current (8/20 $\mu\text{s}$ )	I <sub>PP</sub>	21	A
ESD per IEC 61000-4-2 (Air)	V <sub>ESD</sub>	$\pm 30$	kV
ESD per IEC 61000-4-2 (Contact)		$\pm 30$	
Operating Temperature Range	T <sub>J</sub>	-55 to +125	$^{\circ}\text{C}$
Storage Temperature Range	T <sub>stg</sub>	-55 to +150	$^{\circ}\text{C}$

### **Electrical Characteristics ( $T_A=25^{\circ}\text{C}$ unless otherwise specified)**

Parameter	Symbol	Min	Typ	Max	Unit	Test Condition
Reverse Working Voltage	V <sub>RWM</sub>			3.3	V	
Punch-Through Voltage	V <sub>PT</sub>	3.5			V	I <sub>T</sub> = 2 $\mu\text{A}$
Snap-Back Voltage	V <sub>BR</sub>	4.0			V	I <sub>T</sub> = 1mA
Reverse Leakage Current	I <sub>R</sub>			100	nA	V <sub>RWM</sub> = 3.3V
Clamping Voltage	V <sub>C</sub>			7.0	V	I <sub>PP</sub> = 1A (8 x 20 $\mu\text{s}$ pulse)
Clamping Voltage	V <sub>C</sub>			16	V	I <sub>PP</sub> = 21A (8 x 20 $\mu\text{s}$ pulse)
Junction Capacitance	C <sub>J</sub>		1.0		pF	V <sub>R</sub> = 0V, f = 1MHz

**Typical Performance Characteristics (TA=25°C unless otherwise Specified)**

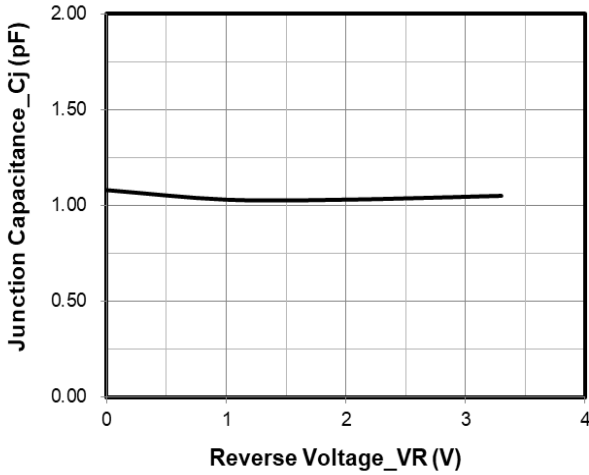

Junction Capacitance vs. Reverse Voltage

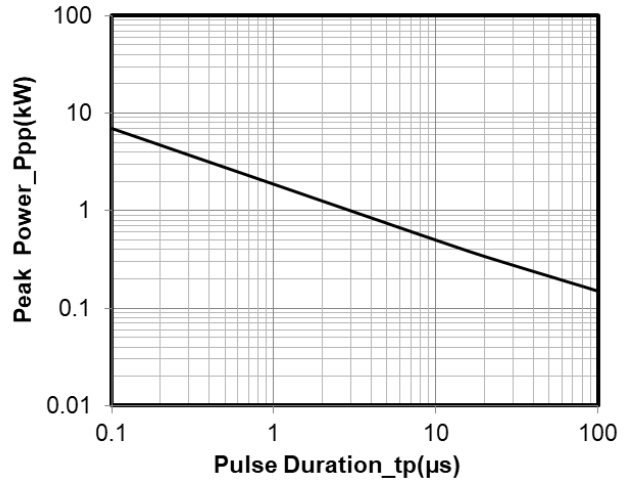

Peak Pulse Power vs. Pulse Time

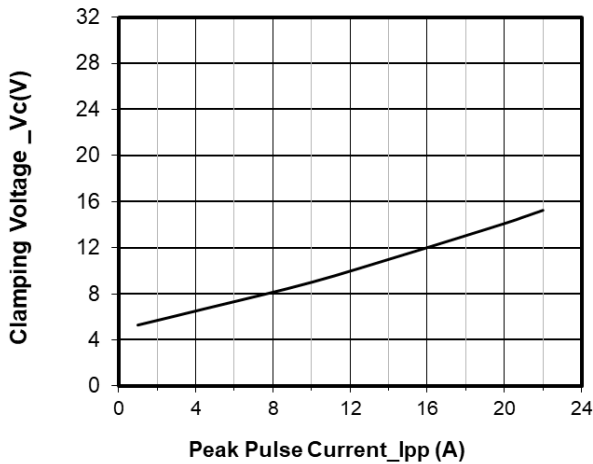

Clamping Voltage vs. Peak Pulse Current

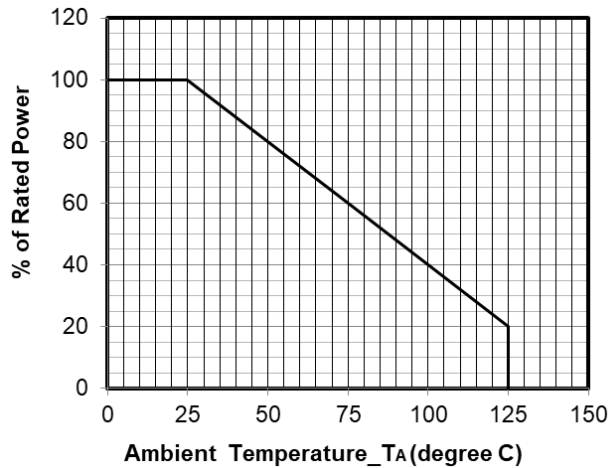

Power Derating Curve

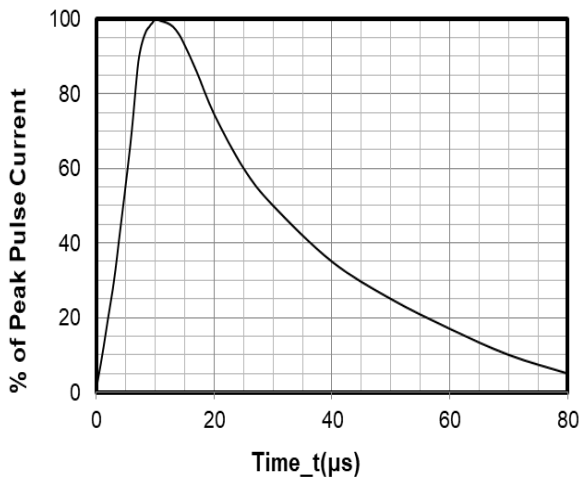

8 X 20μs Pulse Waveform

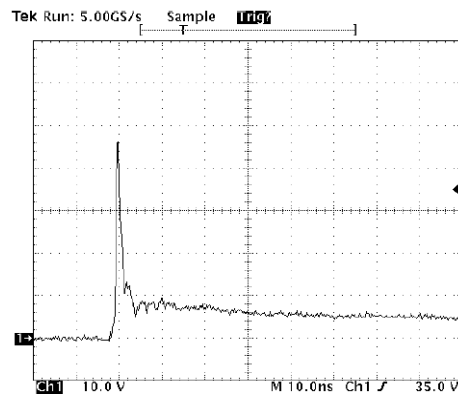

Note: Data is taken with a 10x attenuator  
ESD Clamping Voltage  
8 kV Contact per IEC61000-4-2

## SOD-323 Package Outline Drawing

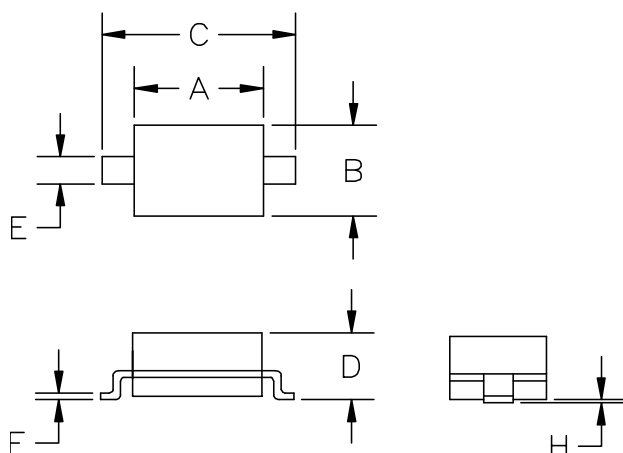

SYM	DIMENSIONS			
	MILLIMETERS		INCHES	
	MIN	MAX	MIN	MAX
A	1.50	1.80	0.060	0.071
B	1.20	1.40	0.045	0.054
C	2.30	2.70	0.090	0.107
D	-	1.10	-	0.043
E	0.30	0.40	0.012	0.016
F	0.10	0.25	0.004	0.010
H	-	0.10	-	0.004

## Suggested Land Pattern

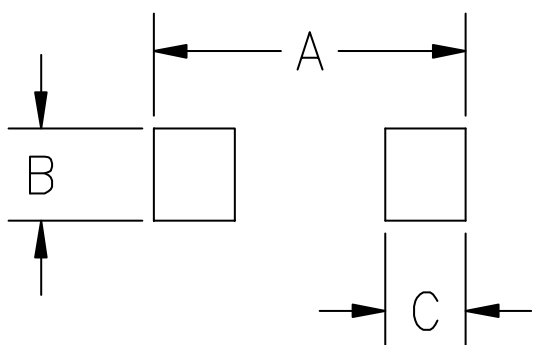

SYM	DIMENSIONS	
	MILLIMETERS	INCHES
A	3.15	0.120
B	0.80	0.031
C	0.80	0.031

## Contact Information

Changzhou D-first Electronics CO.,Ltd.

[www.first-electronic.com](http://www.first-electronic.com)

Email: [xhf@first-electronic.cn](mailto:xhf@first-electronic.cn)

Phone: +86 (0519) 8817 1671